



Emerge.

COLD PLUNGE

2025 OWNER'S MANUAL



115V System

Owner's Record

Locating the Cold Plunge Serial Number:

The Emerge™ serial number label is located inside the equipment compartment. Equipment compartment access panel can be found on page 7. You will need the cold plunge model and serial number to properly register your cold plunge and activate coverage. Write your cold plunge information below.

DATE PURCHASED: _____
PURCHASED FROM: _____
COLD PLUNGE MODEL: _____
SERIAL NUMBER: _____

Please read this Owner's Manual carefully, as it is designed to provide you with the information you will need to ensure the safe, secure use of your cold plunge.

IMPORTANT: Watkins Wellness reserves the right to change specifications and/or design without notification and without any obligation.

Cold Plunge SPECIFICATIONS

Model	Footprint Dimension	Height	Effective Filter Area	Water Capacity	Dry Weight	Filled Weight*	Dead Weight*	Electrical Requirements
EMERGE Seats 1 Adult	88" x 42"	29"	25 ft ²	110 gallons	365 lbs	1,460 lbs	75 lbs/ft ²	115 Volts
	224 cm x 107 cm	74 cm	2.3 m ²	425 liters	165 kg	670 kg	375 kg/m ²	15 amp

- Working Ambient Temperature Range: 20°F (-7°C) to 100°F (38°C).

NOTE: Heat pump will go into error mode when ambient temperature is out of range.

- Water Temperature set range: 40°F (5°C) to 80°F (27°C).

***IMPORTANT:** The "Filled Weight" and "Dead Weight" of the spa includes the weight of the occupants (assuming an average occupant weight of 175lbs [80 kg]).

CAUTION

DO NOT OPERATE COLD PLUNGE BEFORE READING THIS MANUAL

Failure to read this manual and follow its instructions may result in unsafe operation and or permanent damage to your portable cold plunge.

Most cities, counties, states, and countries require permits for exterior construction and electrical circuits. In addition, some communities have codes requiring residential barriers such as fencing and/or self-closing gates on the property to prevent unsupervised access to a pool or cold plunge by children. Be sure to check with your local agencies for specific requirements.

If you need additional information and/or assistance, please contact your local Dealer.

TABLE OF CONTENTS

CONTENTS

SAFETY INFORMATION

IMPORTANT SAFETY INSTRUCTIONS	1
IMPORTANT COLD PLUNGE INSTRUCTIONS	4

INSTALLATION

PLANNING A LOCATION FOR YOUR COLD PLUNGE	5
--	---

EQUIPMENT ACCESS

EQUIPMENT ACCESS PANEL	7
------------------------	---

ELECTRICAL REQUIREMENTS

ELECTRICAL REQUIREMENT	8
------------------------	---

CONTROL PANEL OPERATION

INITIAL START-UP	9
ADJUST TEMPERATURE	9
MULTI COLOR LED LIGHT	9
FAHRENHEIT/CELSIUS	9
SYSTEM & PANEL VERSION	10
NETWORKING SCREEN	10
LOCKING PROTECTION	10
DIAGNOSTIC LCD MESSAGE	11

START-UP & FILL-UP INSTRUCTIONS

POSITION POWER CORD	12
POSITION DRAIN TUBE	12
FILLING COLD PLUNGE WITH WATER	12
APPLYING POWER	13

ADDING START-UP CHEMICALS

WATER CHEMISTRY GUIDELINES	14
----------------------------	----

COLD PLUNGE MAINTENANCE

FILTER CARTRIDGE MAINTENANCE	15
SURFACE CARE	16
COVER CARE	16
CABINET CARE	16
COLD PLUNGE LED REPLACEMENT	16
UV MAINTENANCE	17

DRAINING OR WINTERIZING

DRAINING YOUR COLD PLUNGE	18
WINTERIZING YOUR COLD PLUNGE	18

TROUBLESHOOTING PROCEDURES

GFCI TRIPPING	19
COLD PLUNGE NOT HEATING OR COOLING	19

SAFETY INFORMATION

IMPORTANT SAFETY INSTRUCTIONS

READ AND FOLLOW ALL INSTRUCTIONS

AVOIDING THE RISK TO CHILDREN

DANGER:

- **RISK OF CHILD DROWNING.** Extreme caution must be exercised to prevent unauthorized access by children. To avoid accidents, ensure that children cannot use a cold plunge unless they are supervised at all times.

WARNING:

- To reduce the risk of injury, do not permit children to use this product unless they are closely supervised at all times.
- To reduce the risk of injury, raising water temperatures are recommended for young children. Children are especially sensitive to cold water.

DO:

- Make sure you always lock the child resistant cover locks after using the cold plunge for your children's safety. Every cold plunge is equipped with a locking cover that meets the ASTM F1346-91 Standard for Safety Covers.
- Test the water temperature with your hand before allowing your child to enter the cold plunge to be sure that it's comfortable. Children are especially sensitive to cold water.
- Remind children that wet surfaces can be very slippery. Make sure that the children are careful when entering or exiting the cold plunge.

DON'T:

- Do not allow children to climb onto the cold plunge cover.
- Do not allow children to have unsupervised access to the cold plunge.

AVOIDING THE RISK OF ELECTROCUTION

Risk of Electrocution

- Connect only to a grounded GFCI source.
- Do not bury the power cord. A buried power cord may result in death or serious personal injury due to electrocution if direct burial-type cable is not used, or if improper digging occurs.
- A ground terminal (pressure wire connector) is provided on the control box inside the unit to permit connection of a minimum No. 10 AWG (6 mm²) solid copper bonding conductor between this point and any metal equipment, metal water pipe, metal enclosures of electrical equipment, or conduit within 5 feet (1.5 m) of the unit as needed to comply with local requirements.

WARNING:

- To reduce the risk of electrical shock, replace a damaged cord immediately. Failure to do so may result in death or serious personal injury due to electrocution.
- Your 115 volt cold plunge is provided with a Ground Fault Circuit Interrupter for user and equipment protection. To ensure proper operation of this important safety device, test according to the following instructions per electrical configuration.

115 VOLT, CORD-CONNECTED

- The GFCI is located at the end of the power cord. Before each use, with the unit operating, push the TEST button. The unit should stop operating and the GFCI power indicator will go out.

SAFETY INFORMATION

Wait 30 seconds and then reset the GFCI by pushing the RESET button. The GFCI power indicator will turn on, restoring power to the cold plunge. If the interrupter does not perform in this manner, there may be an electrical malfunction and with it, the possibility of an electric shock. Disconnect the power until the problem has been corrected.

DANGER: RISK OF ELECTRICAL SHOCK

- Install cold plunge at least 5 feet (1.5 m) from all metal surfaces. A cold plunge may be installed within 5 feet (1.5 m) of a metal surface if each metal surface is permanently connected by a minimum No. 10 AWG (6 mm²) solid copper conductor attached to the wire ground connector on the terminal box that is provided for this purpose if in accordance with National Electrical Code.
- Do not permit any electrical appliances, such as a light, telephone, radio, or television within 5 feet (1.5 m) of a cold plunge. Failure to maintain a safe distance may result in death or serious personal injury due to electrocution if the appliance should fall into the cold plunge.
- Install your cold plunge in such a way that drainage is away from the electrical compartment and from all electrical components.

DO:

- Be sure your cold plunge is connected to the power supply correctly - use a licensed electrical contractor.
- Disconnect the cold plunge from the power supply before draining the cold plunge or servicing the electrical components.
- Test the Ground Fault Circuit Interrupter before each use.

DON'T:

- Do not use the cold plunge with the equipment compartment door removed.
- Do not place electrical appliances within 5 feet (1.5m) of the cold plunge.
- Do not use an extension cord to connect the cold plunge to its power source. The cord may not be properly grounded and the connection is a shock hazard. An extension cord may cause a voltage drop, which will cause overheating of the jet pump motor and motor damage.
- Do not attempt to open the electrical control box. There are no user serviceable parts inside.

RISKS TO AVOID

DANGER: RISK OF INJURY

- DO NOT sit in the filter compartment area. Sitting in this area can cause:
 - a) Restriction of Filter Pump suction/ vacuum.
 - b) Damage to components.
- Both can result in bodily harm. Should damage occur to components in this area, replace immediately!
- The suction fittings in the cold plunge are sized to match the specific water flow created by the pump. Never replace a suction fitting with one rated less than the flow rate marked on the original suction fitting.
- There is a danger of slipping and falling. Remember that wet surfaces can be very slippery. Take care when entering or exiting the cold plunge.
- Never operate cold plunge if the suction fittings are broken or missing.
- People with infectious diseases should not use the cold plunge.
- Keep any loose articles of clothing or hanging jewelry away from rotating jets or other moving components.

SAFETY INFORMATION

Increased side effects of medication

- The use of drugs, alcohol or medication before or during cold plunge use may lead to unconsciousness with the possibility of drowning.
- Persons using medications should consult a physician before using a cold plunge; some medication may cause a user to become drowsy, while other medication may affect heart rate, blood pressure, and circulation.
- Persons taking medications which induce drowsiness, such as tranquilizers, antihistamines or anticoagulants should not use the cold plunge.

Health problems affected by cold plunge use

- Pregnant women should consult a physician before using cold plunge.
- Persons suffering from obesity or with a medical history of heart disease, low or high blood pressure, circulatory system problems, or diabetes should consult a physician before using cold plunge.

Unclean water

- Keep the water clean and sanitized with correct chemical care. The recommended levels for your cold plunge are:
Free Available Chlorine (FAC): 3.0 - 5.0 ppm
Total Alkalinity: 40 - 120 ppm
Water pH: 7.2 - 7.8
Calcium Hardness: 75 - 150 ppm

IMPORTANT: Add any cold plunge water chemicals into the filter compartment.

- Clean the filter cartridge monthly to remove debris and mineral buildup which may affect the performance of the hydromassage jets, limit the flow, or trip the high-limit thermostat which will turn off the entire cold plunge.

AVOIDING THE RISK OF HYPOTHERMIA

Prolonged immersion in cold water can result in HYPOTHERMIA, a dangerous condition which occurs when the internal temperature of the body reaches a level several degrees below normal 98.6°F (37°C).

THE SYMPTOMS OF HYPOTHERMIA INCLUDE:

- Slow shallow breathing
- Slurred speech or mumbling
- Shivering
- Weak pulse
- Drowsiness
- Clumsiness
- Confusion
- Unconsciousness
- Possible bright red or cold skin (in infants)

THE EFFECTS OF HYPOTHERMIA INCLUDE:

- Failure of the respiratory system and heart
- Failure of the nervous system
- Failure to recognize the need and when to exit the cold Plunge unit
- Unawareness of impending hazard
- Physical inability to exit the cold plunge
- Fetal damage in pregnant woman
- Unconsciousness resulting in the danger of drowning.

WARNING:

The use of alcohol, drugs, or medication can greatly increase the risk of fatal hypothermia in a cold plunge.

TO REDUCE THE RISK OF INJURY:

- The water in the cold plunge should not go below 40°F (4.5°C). Water temperatures between 40°F (4.5°C) and 80°F (26.5°C) are considered safe for a healthy adult. **Lower water temperatures are not recommended for extended use (exceeding 5 minutes) and 2 minutes for younger children. Extended use can cause hypothermia.**

SAFETY INFORMATION

- Pregnant or possibly pregnant women should limit cold plunge water temperatures to 80°F (26.5°C). Failure to do so using colder temperatures may result in permanent injury to your baby.

AVOIDING THE RISK OF SKIN

BURNS:

- To reduce the risk of injury, before entering a cold plunge the user should measure the water temperature with an accurate thermometer.
- Test the water with your hand before entering the cold plunge to be sure it's comfortable.

SAFETY SIGN

A SAFETY SIGN in the owner's package. The sign, which is required as a condition of Product Listing, should be permanently installed where it is visible to the users of the cold plunge.

IMPORTANT COLD PLUNGE INSTRUCTIONS

The following contains important cold plunge information, and we strongly encourage you to read and apply them.

DO:

- Use and lock the cover when the cold plunge is not in use, whether it is empty or full.
- Follow the Cold plunge Care and Maintenance recommendations stated in this manual.
- Use only approved accessories and recommended cold plunge chemicals and cleaners.

DON'T:

- Do not leave the cold plunge exposed to the sun without water or the cover in place. Exposure to direct sunlight can cause solar distress of the shell material.
- Do not roll or slide the cold plunge on its side. This will damage the siding.
- Do not lift or drag the cover by using the cover lock straps; always lift or carry the cover by using the handles.
- Do not attempt to open the electrical control box. There are no user serviceable parts inside. Opening of the control box by the cold plunge owner will void the warranty. If you have an operational problem, carefully go through the steps outlined in the Troubleshooting section. If you are not able to resolve the problem, contact your authorized dealer. Many problems can easily be diagnosed over the telephone by an Authorized Service Technician.
- Do not spray water from a hose or any other device directly into the vents on the side and back panel. Doing so may cause severe damage to electrical components within the cold plunge unit and such damage would not be covered under the cold plunge warranty.

Cold Plunging for beginners involves the following:

1. Start with water that's between 50°F and 60°F (10°C and 16°C) if never cold plunged before.
2. Don't hesitate, submerge your entire body up to the jaw line.
3. Control your breathing and stay calm.
4. Get out when you start shivering (or before).
5. Gradually ease into building a tolerance to the frigid temperatures.
6. Consider doing a 15 - 30 second shot of cold water at the end of a shower to ease into it.

SAVE THESE INSTRUCTIONS

INSTALLATION

PLANNING A LOCATION FOR YOUR COLD PLUNGE

Consider these things when determining where to place your cold plunge.

SAFETY FIRST:

Make sure your cold plunge is positioned so access to the left side equipment compartment and back panel will not be blocked. Be certain your installation will meet all city and local safety codes and requirements.

PLANNED USE OF COLD PLUNGE:

How you intend to use your cold plunge will help you determine where you should position the cold plunge. For example, will you use it more for recreational or therapeutic purposes? If your cold plunge is mainly for family recreation, leave plenty of room around it for activity and lawn furniture. You will use it more for relaxation and therapy, you'll probably want to create privacy around the cold plunge.

PRIVACY:

Think of your surroundings during all seasons to determine your best privacy options. Consider the view of your neighbors when you plan the location of your cold plunge.

VIEWS:

Think about the direction you will be facing when sitting in your cold plunge. Do you have a special landscape you will find enjoyable? Perhaps there is an area that has a soothing breeze during the day or a lovely sunset in the evening.

ENVIRONMENT:

If you live in a climate with a snowy winter and hot summer, a place to change clothes or a house entry near the cold plunge is convenient. A warmer climate may require shade from the hot sun. Consider placement of trees, shrubs, patio cover or perhaps a gazebo structure to provide what you will need. Indoor installations require

adequate ventilation. When the cold plunge is in use, small amounts of moisture may also be produced. This moisture can damage walls and ceiling surfaces over time. Special paint is available to resist moisture damage. Remember that cold plunge periodically requires drainage, so plan your environment accordingly. The heat pump ¼" (6.4 mm) drain tube will need to be routed away from the cold plunge.

KEEP CLEAN:

Prevent dirt and foliage from being tracked into your cold plunge by utilizing concrete for paths and access areas. Check the location of spill paths from gutters, trees, and shrubs.

SERVICE ACCESS:

Many people choose to install tile or custom wood around their cold plunge. If you are installing your cold plunge with custom decorative trimming, remember to allow for access to it for service. Should you need service, a technician may need to remove the cold plunge door panels. It is always best to design special installations so the cold plunge can still be moved, or lifted from the ground.

A GOOD FOUNDATION:

Your new cold plunge needs a good solid foundation. The area your cold plunge sits on must be able to support the cold plunge, the water in it and those who use it. If the foundation is inadequate, it may shift or settle after the cold plunge is in place, causing stress to the shell or components. It is recommended to place the cold plunge on a 4" (10 cm) concrete pad with steel reinforcement bars crossed throughout the pad. **NOTE:** Do not shim your cold plunge in any manner, as this could cause the cabinet to warp, thereby voiding the warranty.

INSTALLATION

BE AWARE:

Damage caused by inadequate or improper foundation support is not covered by the cold plunge warranty. It is the sole responsibility of the cold plunge owner to provide a proper foundation for the cold plunge.

Make sure the foundation where the cold plunge is placed drains water away from the cold plunge. Proper drainage will keep components dry from rain and wet weather. Your cold plunge weight must always be considered when installing your cold plunge. If you are installing it on an elevated wood deck or other structure, it is advisable to consult a structural engineer or contractor to ensure the structure will support the weight.

IT IS STRONGLY RECOMMENDED THAT A QUALIFIED, LICENSED CONTRACTOR PREPARE THE FOUNDATION FOR YOUR COLD PLUNGE.

A reinforced concrete pad at least four inches thick is recommended for your cold plunge. The reinforcing rod or mesh in the pad should be attached to a bond wire.

INDOOR INSTALLATION:

Be aware of some special requirements if you place your cold plunge indoors. A floor drain is highly recommended.

- Water will need to exit through the front drain located on the lower left side area when draining cold plunge tub (this will require a garden hose to drain water out of the cold plunge and somewhere to drain water in to).
- A 1/4" (6.4 mm) drain tube from the collection pan 12 feet (3.7 m) long is coiled and located inside the equipment compartment. Remove this drain tube (place in cut out) and route to a drain or some type of collection unit. **NOTE:** Up to several gallons of water may exit this tube per day. External collection tray must not be higher than the tray holding the heat pump in place.

- Water will also accumulate around the cold plunge when exiting, so flooring materials must provide a good grip when wet.

NOTE: Proper drainage is essential to prevent water from running all over the floor and under the cold plunge unit. When building a new room for the cold plunge, it is recommended that a floor drain be installed.

It is best to provide plenty of ventilation to the cold plunge area. An architect can help to determine if more ventilation must be installed.

VENTILATION:

The cold plunge unit has two ventilation locations (seen below) the backside panel must be at least 24" (61 cm) away from any wall or obstruction preventing airflow out of the cold plunge (72" [183 cm] is recommended for optimal performance). The side ventilation panel pulls air into the cold plunge and is also the main entrance into the equipment compartment, allow enough space 30" (76 cm) for someone to open and work inside if necessary.

NOTE: The backside panel once removed provides access to removing the heat pump (if necessary) for service.

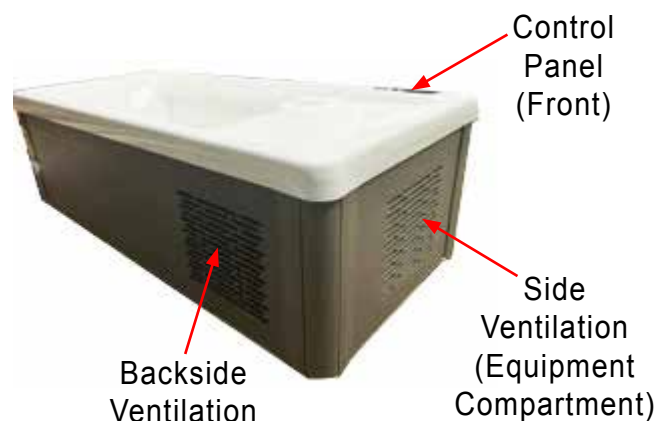

IMPORTANT: BECAUSE OF SHIPPING ORIENTATION, WAIT 24 HOURS TO FILL AND START YOUR COLD PLUNGE ONCE IT IS IN PLACE.

EQUIPMENT ACCESS PANELS



Cold plunge back panel:

To access the back panel compartment:

- There are 3 screws holding one T-part on each side of cold plunge.
- Remove the 6 screws and 2 T-parts from the back Equipment Access Panel Door door.
- Lift panel up slightly from bottom then pull away and lower.

***NOTE:** If the back panel has never been removed before, a small shipping angle bracket will still be attached between side panel and bottom of cold plunge. This bracket will need to be removed before panel can be removed.

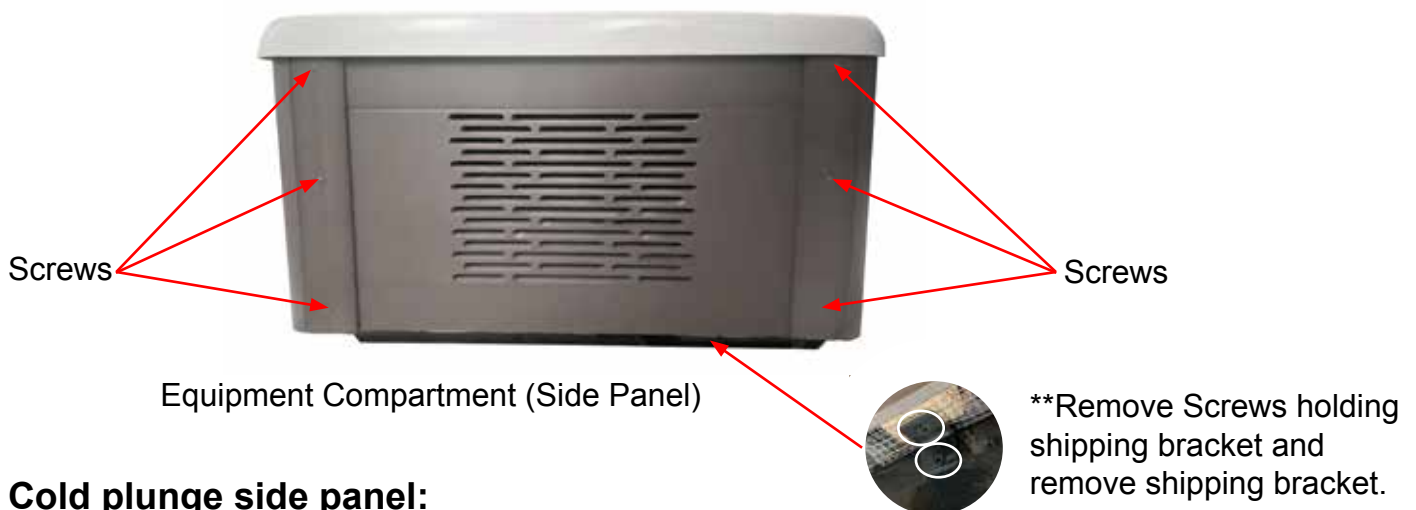

Cold plunge side panel:

To access the equipment compartment:

- There are 3 screws holding one T-part on each side of cold plunge side panel.
- Remove the 6 screws and 2 T-parts from the Equipment Access Panel Door door.
- Lift panel up slightly from bottom then pull away and lower.

****NOTE:** If the side panel has never been removed before, a small shipping angle bracket will still be attached between side panel and bottom of cold plunge. This bracket will need to be removed before panel can be removed.

ELECTRICAL REQUIREMENTS

ELECTRICAL REQUIREMENT

⚠ DO NOT POWER THE COLD PLUNGE WITHOUT FIRST FILLING WITH WATER!

IMPORTANT: BECAUSE OF SHIPPING ORIENTATION, WAIT 24 HOURS TO FILL AND START YOUR COLD PLUNGE ONCE IT IS IN PLACE.

⚠ DANGER – RISK OF ELECTRIC SHOCK

Installations that do not conform to the following procedures and requirements may expose users to electric shock. Non-conforming installations will not be covered under warranty.

If installed in the United States, the electrical wiring of this cold plunge must meet the requirements of the National Electric Code (NEC) and any applicable state or local codes. The electrical circuit (plug) must be installed by an electrical contractor and approved by a local building electrical inspection authority.

1. The electrical supply for the cold plunge must include a suitable rated switch or circuit breaker to open all ungrounded supply conductors to comply with the National Electric Code

2. The 115 V model must use the provided 15 foot (4.5 m) GFCI cord and be plugged directly into a dedicated GFCI grounded circuit wall outlet between 6' (1.8 m) and 10' (3 m) from the cold plunge. Do not use an extension cord or any other disconnect-able power cord. The use of an extension cord or a disconnect-able power cord is highly dangerous and will void all warranties!



115 VOLT INSTALLATION (CORD CONNECTED)

The cold plunge comes with a factory-installed power supply GFCI cord to be plugged into a GFCI grounded circuit 115 volt, 15 amp receptacle. No other electrical appliance or fixture can be used on this circuit. The cord is located inside the Equipment compartment.

IMPORTANT: Under **NO** circumstances should an extension cord be used. Use of an extension cord will seriously degrade the performance of the equipment and can create an electrical hazard.

Electrical Components inside Equipment Compartment



CONTROL PANEL OPERATION

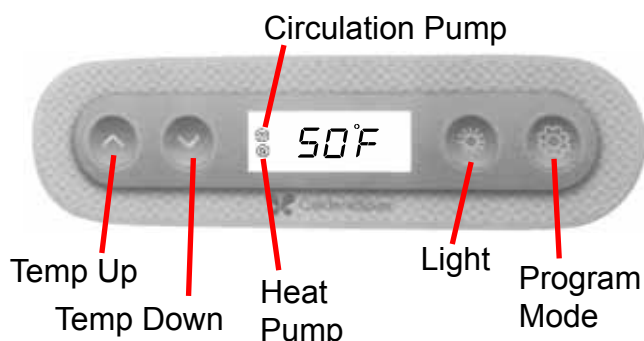

INITIAL START-UP

When the cold plunge is first powered up the control system begins a 2 second Startup Mode. Once Startup Mode completes, the actual water temperature is displayed on the screen, and the cold plunge will then begin to cool and maintain the water temperature.



Your cold plunge has been designed so that it will automatically cool the water to the factory set temperature of 80°F (27°C) unless you set the cold plunge to a different temperature. If power is disconnected from the cold plunge, it will automatically revert back to the last saved set temperature when power is reapplied.

ADJUST TEMPERATURE

When the system is powered on and not in setting mode, press the  or  buttons to display the set temperature.

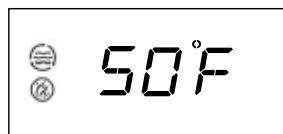

Each time either button is pressed again, the set temperature will increase or decrease depending

on which button is pressed, the system will store the set temperature value. The LCD will then automatically display the current cold plunge temperature.



The temperature can only be set between 40°F - 80°F (5°C - 27°C). The last measured temperature will constantly display on LCD.

NOTE: The Heat pump icon  will Flash on and off when the heat pump is On and remain solid when cold plunge water temperature and set temperature are the same, shutting the heat pump Off.

MULTI COLOR LED LIGHT

There are two different light modes which can be set within the first 5 minutes of power-up by holding the  *Light* button for 8 seconds (until you hear a beep) to switch from one mode to the other. The default mode is Mode 1. **NOTE:** If the light mode you are looking for doesn't come up simply power down the spa and repeat the instructions above.

Mode 1 simply turns a white light on and off by pressing the  *Light* button (no colors).

Mode 2 will provide a multi color selection experience. Press the  *Light* button once to turn on the color wheel, press the  *Light* button again to turn on different light colors. The sequence is as follows:

1st press: Full color wheel between red and white below.

2nd press: Red

3rd press: Green

4th press: Yellow

5th press: Blue

6th press: Purple

7th press: Cyan

8th press: White



9th press: off.

NOTE: If left on, the light will automatically turn off after 1 hour of operation.

FAHRENHEIT/CELSIUS SETTING

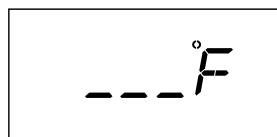
To change water temperature display to either Fahrenheit or Celsius, press the *Program Mode*  button until entering temperature setting



screen where the LCD will display with the temperature unit F or C. Press the  or  button to switch the temperature

unit to °F or °C. The system will automatically store the value after changing.

CONTROL PANEL OPERATION

SYSTEM & PANEL VERSION

When the system is powered on, press the



Program Mode  button several times in a row to see the Firmware version showing the Control box followed by the Control panel. These two screens will only notify you of the version your cold plunge controls currently have in them.

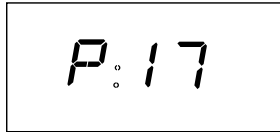

NETWORKING SCREEN

When the system is powered on, press the



Program Mode  button several times in a row to see the Networking Off screen. This is a non-

functioning feature on the cold plunge unit.

LOCKING PROTECTION

The locking screen or Child lock protection screen allows you to prevent anyone from using the



control panel to change current settings.

When the system is powered on, press the

Program Mode  button

several times in a row to see either the Lock On or Lock Off screen.

TO ENABLE the cold plunge lock, press the 

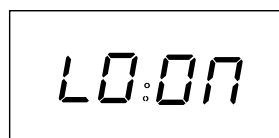

or  button to toggle.

When LO:ON is visible on the screen do not press any buttons and wait for

3 minutes. After 3 minutes



the LOCH screen is displayed locking all button operations. To use control



panel while in lock mode simply hold any button

down for **3 seconds**.

TO DISABLE the lock mode, hold any button down for **3 seconds**. Use the *Program Mode* 

button to go to the Locking screen and press the  or  button to toggle to the LO:OF screen.

CONTROL PANEL OPERATION

DIAGNOSTIC LCD MESSAGE

Message	Meaning	Action Required
	No message on display. Power has been cut off to the cold plunge. Check and reset GFCI on end of power cord.	The control panel will be disabled until power returns. Cold plunge settings will be preserved until next power up.
F10	No Communication between the Control panel and the control box.	Call your Dealer or service provider.
F11	No Communication between the control box and the heat pump.	Call your Dealer or service provider.
E03	Water Flow Failure.	Shut power off and back on (reset) several times if necessary. Clean your filter if dirty.
E04 through E44	Error codes that may require service.	Power down for 5 minutes and power back up. If this doesn't work call your Dealer or service provider.
E20	Error code that indicates the ambient temperature is too hot (above 100°F / 38°C)	Wait until ambient temperature is below 100°F / 38°C then shut power off and back on (reset).

 WARNING! SHOCK HAZARD! NO USER SERVICEABLE PARTS.

Do not attempt service of the control box. Contact your local Dealer for assistance. Follow all owner manual power connection instructions.

START-UP & FILL-UP INSTRUCTIONS

IMPORTANT: BECAUSE OF SHIPPING ORIENTATION, WAIT 24 HOURS TO FILL AND START YOUR COLD PLUNGE ONCE IT IS IN PLACE FOR INITIAL STARTUP!

POSITION POWER CORD

1. Open the Equipment compartment (side panel) door see page 7.

With the Equipment compartment open, uncoil the 15 foot (4.5 m) power cord.

- Determine the distance of the power cord needed from the outlet to the cold plunge.
DO NOT PLUG COLD PLUNGE IN UNTIL IT HAS BEEN FILLED WITH WATER!

- Position the power cord inside the cut out.
- Place any extra cord back into the equipment compartment.



Power Cord in Cut Out

POSITION DRAIN TUBE

With the Equipment compartment open:

1. Unravel the 1/4" (6.4 mm) drain tube 12 feet (3.7 m) long which is coiled and located inside the equipment compartment. This tube is attached to the collection pan underneath the large heat pump.
2. Position this drain tube (place in cut out, same as power cord above) and route to a drain or some type of collection unit out side of cold plunge if installed indoors. **NOTE:** Up to several gallons of water may exit this tube per day. External collection tray if used must not be higher than the tray holding the heat pump in place.
3. Place in any preferred location outside of the cold plunge if installed outdoors (use cut out). This drain tube can also be cut if too long.

The following procedures should be followed on initial startup and whenever the cold plunge is drained for routine maintenance.

FILLING THE COLD PLUNGE WITH WATER

1. Clear all the debris from your cold plunge.
2. Verify Drain valve is closed and drain cap is attached and tight.
3. Remove Filter Lid.
4. Insert a garden hose into filter compartment to fill your cold plunge.

IMPORTANT: Do not fill with hot or softened water. If ambient temperatures are above 105° F (40.5°C) the cold plunge heat pump may not be able to start cooling the water when power is applied until the ambient temperature cools down below 105° F (40.5°C). NOTE: Direct sun may also warm up the inside of the equipment compartment making it hotter than the outside ambient temperature.

5. Under normal circumstances keep the water level just above the top of the upper equalizer fitting of the cold plunge.

Failure to keep enough water in your cold plunge may result in damage to your system and invalidate your warranty. If your cold plunge filter is sucking in air causing the pump to cavitate, you need to add water!

6. Check the filter installation and make sure the filter is not loose.

IMPORTANT: Remember to change your water every three to six months.

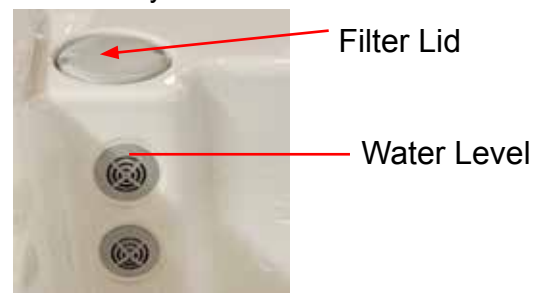

FILL-UP AND START-UP INSTRUCTIONS

APPLYING POWER

1. Turn power to cold plunge "ON" by plugging GFCI into the wall outlet.
2. **WATKINS WELLNESS** recommends that the GFCI be tested prior to each use to ensure it is functioning correctly. With the cold plunge connected to the power supply, push the yellow "Test" button. The cold plunge should stop operating and the GFCI power indicator will go out. Wait 30 seconds and then reset the GFCI by pushing the red Reset button. The GFCI power indicator will turn on, restoring power to the cold plunge. If the interrupter does not perform in this manner, it is an indication of an electrical malfunction and the possibility of an electric shock. Disconnect the plug from the receptacle until the fault has been identified and corrected.
3. Once powered up, if E03 message is visible on the control panel there is an air lock in the circulation pump. Disconnect power, and turn back on. This may be required several times before water begins flowing through the pump.
4. While the circulation pump is running, check for water leaks at the drain, unions, or fittings in the equipment compartment (leaks may have occurred during transit). If water is leaking from one of these areas, there is no need to call for service. Simply tighten the fitting. If assistance is required, contact your local Dealer.
5. After checking your cold plunge for leaks it is now time to adjust your cold plunge settings. Press the *temp up* or *temp down* button on your topside control panel until the display indicates your desired temperature is set.

Equipment Compartment



Power Cord & Drain Tube in cut out area

ADDING START-UP CHEMICALS

WATER CHEMISTRY GUIDELINES

Cold plunge water chemistry is ultimately the responsibility of the cold plunge owner. Improper water chemistry may result in costly repairs not covered under the cold plunge warranty. If unsure about any steps in the process below, please contact your local Dealer.

Initially, it is advisable to identify what minerals (e.g. iron) are present in the local source water. This will provide a better understanding of how to treat the water. Please follow the four steps below and be sure to achieve the correct levels in each area before moving onto the next step. ADD all chemicals into filter compartment.

STEP #1: MEASURE TOTAL ALKALINITY:

The Total Alkalinity is the amount of bicarbonates, carbonates, and hydroxides present in the cold plunge water. Proper total alkalinity is important for pH control. If the TA is too high, the pH is difficult to adjust. If the TA is too low, the pH will be difficult to hold at the proper level. The ideal range is between 40-120 parts per million (PPM). Reduce TA by using an Alkalinity Down/Decreaser (sodium bisulfate). Increased TA by adding an Alkalinity Up/Incraser (sodium bicarbonate or sodium hydrogen carbonate). These products should be added in small amounts – 5 ml at a time. After adding 5 ml, wait one half hour before re-measuring. Once the safe range of total alkalinity is established, proceed to the next step.

STEP #2: ESTABLISH PROPER PH LEVEL:

The recommended range for pH is between 7.2 and 7.8. Above 7.8, the water is too alkaline and can result in cloudy water, and scale formation on the shell and heater. To lower the pH use a pH Down/Decreaser (sodium bisulfate). Below 7.0 (considered neutral), the cold plunge water is too acidic

and can damage the heating system. To increase pH, use a pH Up/Incraser (sodium hydrogen carbonate). Any pH Up or Down should be added one teaspoon at a time, waiting one-half hour between application and re-measuring.

STEP #3: DETERMINE CALCIUM HARDNESS:

It is important to bring the calcium reading to between 75-150 PPM. If the reading requires adjustment, it should now be corrected. If the water is too soft (a low reading) calcium hardness should be added to the water to increase the PPM reading. If the water is too hard (a high reading), it can be corrected by either: (A) a mixture of hard and soft water added to attain a reading in the safe range, or (B) addition of stain and scale control. If calcium hardness is a problem with the local source water (either too hard or too soft) a test kit, which measures calcium hardness, is essential.

STEP #4: SANITIZING:

After steps 1-3 are complete, **the cold plunge must be sanitized using Chlorine (sodium dichlor)**. Add 2 teaspoons of Chlorine, and increase as necessary to reach a level of 3-5 ppm. Check and maintain this level weekly, and before and after using the cold plunge. **IMPORTANT NOTE:** *A granulated sodium dichlor is highly recommended for sanitizing cold plunge water, granular bromine may also be used. Never use compressed sanitizers even with a floater. As with any other chemicals, the sanitizer should be introduced to the cold plunge in the filter compartment.*

COLD PLUNGE MAINTENANCE

FILTER CARTRIDGE MAINTENANCE

Every month, the filter cartridge should be cleaned to remove the objects and particles that have lodged in the cartridge pleats. Using household water pressure and a garden hose with a pressurized nozzle, push water from inside to outside of the pleats, forcing all the trapped particles out.

NOTE: Never run your cold plunge without a filter cartridge!!! This will invalidate your warranty.

NOTE: Filter cartridges should be replaced every six to eight months or earlier when needed. Dirty filters can cause your cold plunge pump to burn out and will invalidate your warranty.

FILTER CARTRIDGE REMOVAL AND CLEANING INSTRUCTIONS

Cold plunge uses a screw in filter cartridge that is easily removed.

- Turn off the power to the cold plunge, (by unplugging the cold plunge unit).
- Remove filter lid Figure 1.
- Unscrew the filter cartridge counter clockwise and bring it out of the cold plunge (requires many turns) Figure 2.



Figure 1



Figure 2

- Rinse cartridge using a garden hose. Rotate and separate filter pleats while spraying water to remove all dirt and debris possible. Let filter dry and look for calcium deposits (scaling) or an oil film. If you find these, you will need to deep clean your filter cartridge with a “cold plunge filter cleaner” solution to break down and remove unwanted deposits and oils. (For longer filter life you should soak filter regularly).

CAUTION! Always use proper eye protection when using chemicals, or high-pressure water. Read instructions on cleaning products and follow applicable safety and warning instructions listed on label.

CAUTION! Never scrub the filter cartridge with a brush, as this will cause the filter to wear out and come apart. Never let the cold plunge pump run without a filter cartridge in the skimmer compartment. Running the cold plunge without a filter cartridge may permit debris to enter the cold plunge plumbing and void the warranty!

- Replace filter cartridge, (insert and rotate clockwise to lock into position). **DO NOT OVERTIGHTEN!**
- Plug cold plunge back in to power up.

COLD PLUNGE MAINTENANCE

SURFACE CARE

Do not use solvents or abrasive cleaners to clean the cold plunge. Typically, a mild detergent and water will resolve cleaning issues.

COVER CARE

The cover is made with a solution dyed polyester fabric and is an attractive, durable foam insulation product. Monthly cleaning is recommended to maintain its beauty and a longer fabric life.

To clean and condition the polyester cover:

1. Remove and gently lean against a wall or fence.
2. With a garden hose, spray the covers to loosen and rinse away dirt or debris.
3. Add four tablespoons of mild soap or mild dishwashing liquid with one gallon (4 liters) of lukewarm water. Clean using a soft bristle brush. Rinse thoroughly with cold water and air dry.

IMPORTANT: Do not let the polyester dry with a soap film on it before it can be rinsed clean.

4. Scrub the cover's perimeter and side flaps. Rinse clean with cold water.
5. Rinse off the underside of the cover with water only (use no soap), and wipe it clean with a dry rag.

CABINET CARE

Little maintenance is required to keep your cold plunge cabinet looking good.

Cold plunge cabinet product should be cleaned as needed to remove dirt and debris.

- NO abrasive or harsh chemicals should be used on the cold plunge's cabinet.
- NO solvents or cleaners containing aromatic solvents should be used on the cold plunges cabinet.
- Hot soapy water is the best choice for cleaning the cold plunge's cabinet.

COLD PLUNGE LED REPLACEMENT

- Turn OFF the power to the cold plunge (unplug).
- Remove the Back Panel (see page 7).



- Locate the cold plunge light location.



- Peel Craft paper from bottom right side to expose the light.

- To remove the LED housing and board, turn outside housing counter clockwise ¼ turn and remove.



- Pull out and remove LED board from socket.
- Replace by reversing the above steps.

COLD PLUNGE MAINTENANCE

UV MAINTENANCE

The Ultraviolet System will require maintenance in order to help keep your water clean. The following maintenance schedule is recommended:

- Replacing of the UV-C (20) lamp every twelve months. This is fairly simple and can be done by the cold plunge tub owner or call your dealer if you don't feel comfortable doing the replacement below.
- Cleaning of the Quartz Tube is necessary whenever your UV system isn't functioning correctly. Contact your dealer for Quartz Tube cleaning. **NOTE:** UV-C lamp replacement could be done at the same time. The Quartz tube (6) cleaning will require the draining of the Cold Plunge unit.

UV-C LAMP REPLACEMENT

- Unplug the Cold Plunge unit.

⚠ WARNING: Make sure UV-C lamp (20) is cool before removing. Latex gloves must be worn when installing a new lamp to prevent damage from the oils on your skin.

⚠ DANGER: Never look at the UV-C lamp (20) when on, this can cause severe eye damage or blindness.

- Remove Equipment compartment door.
- Remove enclosure cover (14) by removing the 4 screws (15).
- Disconnect UV-C lamp connector (17) from ballast connector (16).

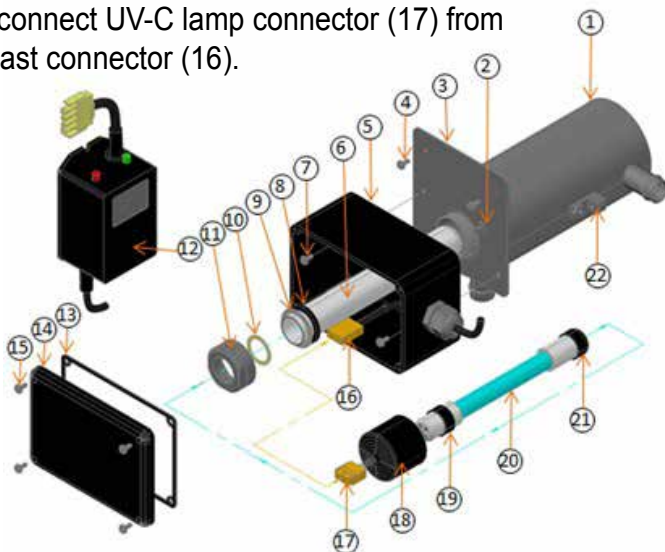

- Slowly remove boot cover (18) and UV-C lamp (20) from quartz tube (6).

Replace new UV-C lamp as follows:

- Slide the new UV-C lamp (20) back inside the quartz tube (6). Install boot cover (18) over compression nut (11).
- Reconnect the UV-Clamp connector (17) to the ballast connector (16). Make sure the connector mates completely. Do not use force.
- Reinstall the enclosure cover (14) with gasket (13 see below) and secure with screws (15).
- Replace Equipment compartment door.
- Plug the Cold Plunge back into outlet.

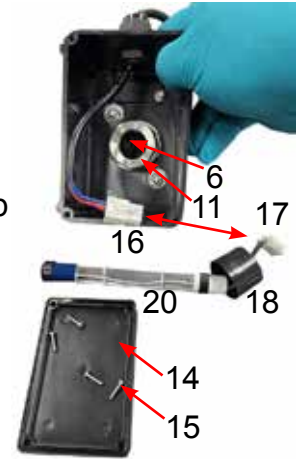

WARNING: The UV-C lamp used in this unit contains mercury. Properly dispose of the old UV-C lamp in accordance with disposal laws. See lamprecycle.org.

KEY	DESCRIPTION
1	REACTION CHAMBER
2	NUT KEP
3	MOUNTING BRACKET
4	MOUNTING SCREW (NOT PROVIDED)
5	ELECTRICAL ENCLOSURE
6	QUARTZ TUBE
7	SCREW 8-32 X 3/8"
8	QUARTZ SEAL GASKET
9	COMPRESSION WASHER
10	PLASTIC WASHER
11	COMPRESSION NUT
12	ELECTRONIC BALLAST
13	ENCLOSURE GASKET
14	ENCLOSURE COVER
15	SCREW #8 X 5/8"
16	BALLAST CONNECTOR
17	LAMP CONNECTOR
18	BOOT COVER
19	UPPER CUSHION
20	UV LAMP
21	LOWER CUSHION

DRAINING OR WINTERIZING

Every three to six months, depending upon the water condition, you need to renew your water.

CAUTION: READ THIS BEFORE DRAINING YOUR COLD PLUNGE!

- To prevent damage to the cold plunge's components, **UNPLUG GFCI CORD OR TURN OFF SUBPANEL BREAKER BEFORE DRAINING. Do not power back up until your cold plunge has been refilled with water.**
- There are certain precautions to keep in mind when draining your cold plunge. If it is extremely cold, and the cold plunge is outdoors, freezing could occur in the plumbing or the equipment.
- Do not leave the cold plunge's shell (inside surface) exposed to direct sunlight.

DRAINING YOUR COLD PLUNGE

- Unscrew and remove the drain cap.
- Attach hose bib to a garden hose and direct to an appropriate draining area, keeping the hose below the water line.
- Open Valve to drain.
- After your cold plunge is empty, clean the shell and filter cartridge. See "cold plunge Maintenance" section.
- After cleaning, remove garden hose, replace drain cap, close drain valve and push the hose bib back into the recess.
- Follow the "Fill up and Start-up Instructions" on page 12.



Drain Cap

WINTERIZING YOUR COLD PLUNGE

If you plan to store your cold plunge for the winter, you must also use a wet-vac to clean out the water lines to ensure they are free of any water. Water left in the lines might freeze and damage the lines and pump.

1. Drain your cold plunge.
2. It will be necessary to remove all water from the interior plumbing.
3. Remove the filter cartridge. Clean the filter cartridge and store in a dry place. Attach the vacuum hose to the **vacuum side** of the shop vac and thoroughly dry the filter compartment.
4. Using the shop vac, remove the water

NOTE: When removing the water from drain opening, you may notice suction coming from bottom of filter bucket. With the help of a second person, block off any suction from the filter suction fitting using a large rag or cloth. This will help pull out the water that is trapped deep inside the main line.

5. Thoroughly dry the cold plunge shell with a clean towel.
6. Using a funnel, pour Propylene glycol anti-freeze into the filter suction fitting and drain.
CAUTION: Use only Propylene glycol as your anti-freeze. This is non-toxic. NEVER use automobile anti-freeze since it is toxic.
7. Replace the equipment compartment door and secure with screws.

IMPORTANT: Before using your cold plunge make sure to thoroughly dilute and remove any Propylene glycol first.

NOTE: Damage caused by improper winterizing will not be covered under warranty. You may want to contact your local Dealer to properly winterize your cold plunge.

TROUBLESHOOTING GUIDE

In the event the cold plunge is not working the way it should, please first review all the installation and operating instructions in this manual and check the message on the panel display. If you are still not satisfied it is working properly, please follow the appropriate troubleshooting instructions.

CAUTION! WARNING! SHOCK HAZARD! No User Serviceable Parts.

Do not attempt service of the control box. Contact your local Dealer for assistance. Follow all owner's manual power connection instructions.

GFCI TRIPING

The Ground Fault Circuit Interrupter (GFCI) is a safety device that is designed to detect as little as 5 milliamps ($\pm 1\text{mA}$) of electrical current leakage to ground. **WATKINS WELLNESS** recommends that the GFCI be tested prior to each use to ensure it is functioning correctly. With the cold plunge connected to the power supply, push the yellow "Test" button. The cold plunge should stop operating and the GFCI power indicator will go out. Wait 30 seconds and then reset the GFCI by pushing the red Reset button. The GFCI power indicator will turn on, restoring power to the cold plunge. If the interrupter does not perform in this manner, it is an indication of an electrical malfunction and the possibility of an electric shock. Disconnect the plug from the receptacle until the fault has been identified and corrected.



IMPORTANT: Failure to wait 30 seconds before resetting the GFCI may cause the Power indicator to blink. If this occurs, repeat the GFCI test procedure.

Never use the GFCI as a means to disconnect power to the spa (always unplug it). If the GFCI is tripped while plugged in, and a power outage occurs, when power returns the GFCI will automatically reset and power will flow to the cold plunge.

COLD PLUNGE NOT HEATING OR COOLING

Should you notice the cold plunge is not heating or cooling while power is still available check the following:

1. Check both the Heat Pump and Circulation Pump icon on the control panel.

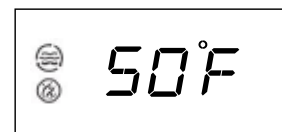

- The Heat pump icon  will Flash on and off when the heat pump is On . If there is a difference of 2° **between the set temperature and actual temperature** the heat pump should come on.
 - The Circulation pump icon should be On and solid at all times.
2. Make sure your set temperature is set to your desired temperature. Adjust if necessary.
 3. If the cover to your cold plunge has been left off for a while this could cause the actual water temperature to be different from the set temperature. Place cover on top of cold plunge if it has been off for a while and allow some time for the actual water temperature to get to the set set water temperature.
 4. Should an error message show up on the screen, shut power off for 5 minutes and then power back on. If the error message comes back on see page 11 first then contact your local Dealer if needed.



Watkins Wellness®

Feel good. Live well.

1280 Park Center Drive
Vista, California 92081
(888) 961-7727

©2024 WATKINS WELLNESS.



300744.25



300744.25 A (12/24)